



PRODUCT TECHNICAL DATASHEET

HDA Undercut anchor

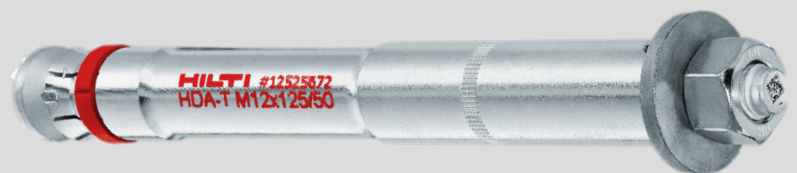

Steel-to-concrete

Update: Feb-26





HDA Undercut anchor

Heavy-duty undercut anchor

Anchor version	Benefits
 <p>Anchor for pre-setting</p> <p>HDA-P (M10-M20) HDA-PF (M10-M16) HDA-PR (M10-M16)</p>	<ul style="list-style-type: none"> - Combines the flexibility and immediate loading capability of a post-installed mechanical anchor with the performance of a cast-in-place headed stud - Close spacing and small edge distances thanks to low expansion forces - Self-undercutting facilitates faster and more reliable installation without need for a separate undercutting tool or additional operations
 <p>Anchor for through-fastening</p> <p>HDA-T (M10-M20) HDA-TF (M10-M16) HDA-TR (M10-M16)</p>	<ul style="list-style-type: none"> - The resulting keying effect provides a more secure hold even in cracked concrete under dynamic loading - Manufactured under an NQA-1 nuclear quality assurance program with comprehensive approval

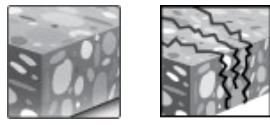
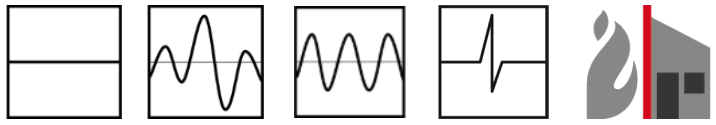
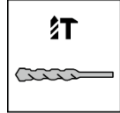

Base material	Load conditions
 <p>Concrete (uncracked) Concrete (cracked)</p>	 <p>Static/quasi-static Seismic, C1, C2 Fatigue Shock BZS-CH Fire resistance</p>
Drilling, cleaning, setting	Other information
 <p>Hammer drilled holes</p>	 <p>Tracefast 100/120 YEARS ETA Working life 100/120 years NQA-1 Nuclear quality assurance Hilti technical data PROFIS Engineering Software Steel to concrete handbook</p>

Linked Approvals/Certificates and Instructions for use

Approvals/certificates













Approval no	Application / loading condition	Authority / Laboratory	Date of issue	Date of expiry
ETA-99/0009	Static and quasi-static / Seismic /Fire (50 / 100 years)	CSTB, Marne-la-Vallée	01-12-2025	-
ETA-18/0974	Fatigue	DIBt, Berlin	17-07-2025	-
ETA-25/1043	Static and quasi-static / Seismic /Fire (120 years)	CSTB, Marne-la-Vallée	01-12-2025	-
BZS D 09-601	Shockproof fastenings in civil defence installations	Federal Office for Civil Protection, Bern	31-10-2020	31-10-2030
Z-21.1-1987	Nuclear power plants	DIBt, Berlin	16-04-2025	16-04-2030
Hilti Technical Data	Static and quasi-static (HDA –PF and -TF versions)	Hilti Corp.	-	-

The instructions for use can be viewed using the link in the instructions for use table or the QR code/link in the Hilti webpage table.

Instructions for use (IFU)

Anchor version	M10	M12	M16	M20
P	IFU HDA M10/12-P/PR/PF		IFU HDA M16-P/PR/PF	IFU HDA M20-P
T	IFU HDA M10/M12-T/TR/TF		IFU HDA M16-T/TR/TF	IFU HDA M20-T
Filling set	IFU Filling set			

Link to Hilti Webpage

Anchors					
HDA-P	HDA-T	HDA-PR	HDA-TR	HDA-PF	HDA-TF
					
Tools					
Setting tool		Stop drill bit		Removal tool	Undercut tool
TE-C-HDA-ST	TE-Y-HDA-ST	TE-C-HDA-B	TE-Y-HDA-B	TE-C-HDA-RT	TE-C-HDA-GT
					

Fastener special dimensions

Anchor dimensions

Anchor size		HDA-P / HDA-PR / HDA-T / HDA-TR / HDA-PF / HDA-TF							
		M10		M12		M16		M20 ¹⁾	
		x100/20	x125/30	x125/50	x190/40	x190/60	x250/50	x250/100	
Length code letter		I	L	N	R	S	V	X	
Total length of bolt	l_B [mm]	150	190	210	275	295	360	410	
Diameter of bolt	d_B [mm]	10	12		16		20		
Length of sleeve	HDA-P l_s [mm]	100	125	125	190	190	250	250	
	HDA-T l_s [mm]	120	155	175	230	250	300	350	
Max. diameter of sleeve	d_s [mm]	19	21		29		35		
Diameter of washer	d_w [mm]	27	32		45		50		
Width across flats	SW [mm]	17	19		24		30		

¹⁾HDA M20: only galvanized 5 μ m version is available.

Anchor Type	Material / Coating
HDA-P / HDA-T	Carbon steel, galvanized to min. 5 μ m
HDA-PF / HDA-TF	Carbon steel, sherardized
HDA-PR / HDA-TR	Stainless steel A4

HDA-P / HDA-PF / HDA-PR (M10 / M12 / M16)
with Spring washer

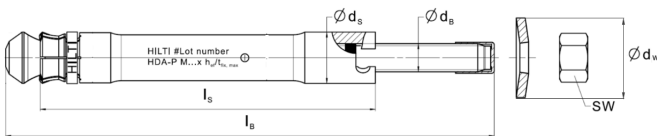

HDA-P (M20) with Flat washer

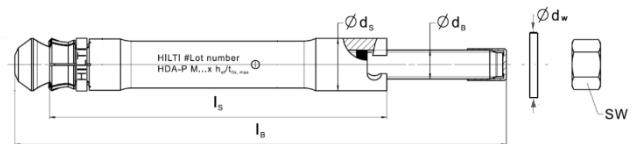

HDA-T / HDA-TF / HDA-TR (M10 / M12 / M16)
with Spring washer

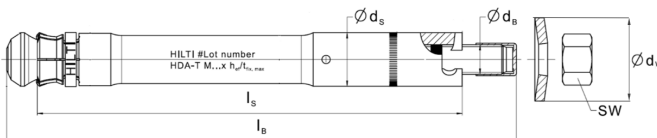

HDA-T (M20) with Flat washer

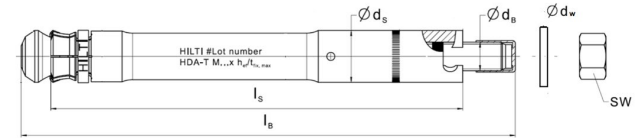



Hilti filling set with Injection mortar Hilti HIT-HY...

Dimensions of the Filling Set

Anchor type		HDA-P(R) / HDA-T(R) / HDA-P(F) / HDA-T(F)			HDA-P / HDA-T
Anchor size		M10	M12	M16	M20
Diameter	d_{vs} [mm]	42	44	52	60
Height of filling washer	h_{vs} [mm]	5	5	6	6
Height of filling washer and spherical washer	h_{fs} [mm]	9	10	11	13

Sealing washer

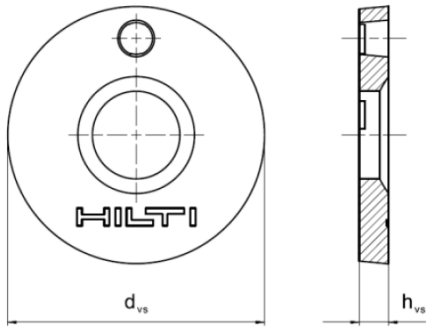

Spherical washer

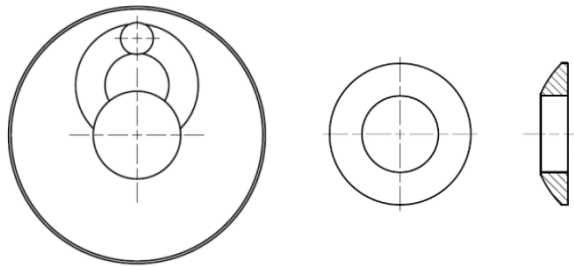

Filling Set

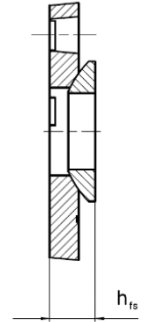

Static and quasi-static loading based on ETA-99/0009 for HDA-P / HDA-PR / HDA-T / HDA-TR and Hilti technical data for HDA-PF and HDA-TF. Design according to EN 1992-4

All data in this section applies to:

- Correct setting (see Instructions for use (IFU))
- For a single anchor
- No edge distance and spacing influence (see setting detail tables with characteristic distances)
- Characteristic spacing and edge distance for splitting failure apply only for uncracked concrete.
- For cracked concrete only the characteristic spacing and edge distance for concrete cone failure are decisive
- Minimum base material thickness (see setting detail table)
- Embedment depth, as specified in the table of this section
- Anchor material, as specified in the tables of this section
- The data given below are for 50 and 100-year working life
- Concrete C20/25
- Hammer drilled holes
- Recommended loads: With overall partial safety factor for action $\gamma = 1,4$.

For specific design cases refer to [PROFIS Engineering](#).

Design resistance: Tension

Anchor size	M10	M12	M16	M20
Effective anchorage depth h_{ef} [mm]	100	125	190	250
Uncracked concrete				
HDA-P, HDA-PF HDA-T, HDA-TF	30,7	44,7	84,0	128,0
N_{Rd} [kN]				
HDA-PR, HDA-TR	28,8	41,9	78,8	-
Cracked concrete				
HDA-P, HDA-PF HDA-T, HDA-TF	26,5	37,1	69,5	104,9
N_{Rd} [kN]				
HDA-PR, HDA-TR	26,5	37,1	69,5	-

Design resistance: Shear for uncracked and cracked concrete

Anchor size	M10	M12	M16	M20
Effective anchorage depth h_{ef} [mm]	100	125	190	250
With and Without Hilti filling set				
HDA-T, HDA-TF	$t_{fix,min}$ [mm]	10 15	10 15 20 15	25 30 35 20 25 40 55
	$t_{fix,max}$ [mm]	<15 20	<15 <20 50	<25 <30 <35 60 <25 <40 <55 100
	V_{Rd} [kN]	40,5 46,7	51,7 53,3 66,7	94,1 103,3 113,3 126,7 121,8 136,7 156,7 166,7
HDA-TR	$t_{fix,min}$ [mm]	10	10 30	15 -
	$t_{fix,max}$ [mm]	20	<30 50	60 -
	V_{Rd} [kN]	58,1	73,2 82,0	128,6 -
Without Hilti filling set				
HDA-P, HDA-PF	21,1	30,2	54,2	83,2
V_{Rd} [kN]				
HDA-PR	18,9	28,6	57,2	-
With Hilti filling set				
HDA-P, HDA-PF	23,4	33,8	57,4	88,8
V_{Rd} [kN]				
HDA-PR	22,6	34,0	63,8	-



Recommended loads: Tension

Anchor size		M10	M12	M16	M20
Effective anchorage depth	h_{ef} [mm]	100	125	190	250
Uncracked concrete					
HDA-P, HDA-PF HDA-T, HDA-TF	N_{rec} [kN]	21,9	31,9	60,0	91,4
HDA-PR, HDA-TR		20,5	29,9	56,3	-
Cracked concrete					
HDA-P, HDA-PF HDA-T, HDA-TF	N_{rec} [kN]	19,0	26,5	49,6	74,9
HDA-PR, HDA-TR		19,0	26,5	49,6	-

Recommended loads: Shear for uncracked and cracked concrete

Anchor size		M10		M12		M16				M20					
Effective anchorage depth	h_{ef} [mm]	100		125		190				250					
with and without Hilti filling set															
HDA-T, HDA-TF	$t_{fix,min}$ [mm]	10	15	10	15	20	15	25	30	35	20	25	40	55	
	$t_{fix,max}$ [mm]	<15	20	<15	<20	50	<25	<30	<35	60	<25	<40	<55	100	
	V_{rec} [kN]	29,0	33,3	37,0	38,1	47,6	67,2	73,8	81,0	90,5	87,0	97,6	111,9	119,0	
HDA-TR	$t_{fix,min}$ [mm]	10		10		30		15				-			
	$t_{fix,max}$ [mm]	20		<30		50		60				-			
	V_{rec} [kN]	41,5		52,3		58,5		91,9				-			
without Hilti filling set															
HDA-P, HDA-PF	V_{rec} [kN]	15,1		21,5		38,7				59,4					
HDA-PR		13,5		20,4		40,9				-					
with Hilti filling set															
HDA-P, HDA-PF	V_{rec} [kN]	16,7		24,1		41,0				63,4					
HDA-PR		16,2		24,3		45,5				-					

Seismic loading based on ETA-99/0009 for HDA-P / HDA-PR / HDA-T / HDA-TR Design according to EN 1992-4

All data in this section applies to:

- Correct setting (see Instructions for use (IFU))
- For a single anchor
- No edge distance and spacing influence (see setting detail table with characteristic distances)
- Minimum base material thickness (see setting details table)
- Embedment depth, as specified in the table of this section
- Anchor material, as specified in the tables of this section
- The data given below are for 50 and 100-year working life
- Concrete C20/25
- Hammer drilled holes
- $\alpha_{\text{gap}} = 1,0$ (using Hilti filling set) and $\alpha_{\text{gap}} = 0,5$ (without using Hilti filling set) accordingly

For specific design cases refer to [PROFIS Engineering](#).

Design resistance in case of seismic performance category C2: Tension

Anchor size		M10	M12	M16	M20
Effective anchorage depth	h_{ef} [mm]	100	125	190	250
Cracked concrete					
HDA-P, HDA-T	$N_{\text{Rd,C2}}$ [kN]	26,5	37,1	69,5	104,9
HDA-PR, HDA-TR		26,5	37,1	69,5	-

Design resistance in case of seismic performance category C2: Shear

Anchor size		M10				M12				M16				M20			
Effective anchorage depth	h_{ef} [mm]	100				125				190				250			
Without filling set ($\alpha_{\text{gap}} = 0,5$)																	
HDA-T	$t_{\text{fix,min}}$ [mm]	10	15	10	15	20	15	25	30	35	20	25	40	55			
		$t_{\text{fix,max}}$	<15	20	<15	<20	50	<25	<30	<35	60	<25	<40	<55	100		
	$V_{\text{Rd,C2}}$ [kN]	12,2	14,0	18,1	18,7	23,4	28,0	31,0	34,0	38,0	42,7	48,0	55,0	58,4			
HDA-TR	$t_{\text{fix,min}}$ [mm]	10		10	20	30	15	25	35		-						
		$t_{\text{fix,max}}$	20		<20	<30	50	<25	<35	60		-					
	$V_{\text{Rd,C2}}$ [kN]	16,2		23,0	24,8	28,6	34,2	35,7	38,4		-						
With filling set ($\alpha_{\text{gap}} = 1,0$)																	
HDA-T	$t_{\text{fix,min}}$ [mm]	10	15	10	15	20	15	25	30	35	20	25	40	55			
		$t_{\text{fix,max}}$	<15	20	<15	<20	50	<25	<30	<35	60	<25	<40	<55	100		
	$V_{\text{Rd,C2}}$ [kN]	24,3	28,0	36,2	37,3	46,7	56,0	62,0	68,0	76,0	85,3	96,0	110,0	116,7			
HDA-TR	$t_{\text{fix,min}}$ [mm]	10		10	20	30	15	25	35		-						
		$t_{\text{fix,max}}$	20		<20	<30	50	<25	<35	60		-					
	$V_{\text{Rd,C2}}$ [kN]	32,3		45,9	49,6	57,1	68,4	71,4	76,7		-						
Without filling set ($\alpha_{\text{gap}} = 0,5$)																	
HDA-P	$V_{\text{Rd,C2}}$ [kN]	9,5				11,1				22,4				33,2			
HDA-PR		8,7				13,6				27,4				-			



Design resistance in case of seismic performance category C2: Shear

Anchor size		M10	M12	M16	M20
With filling set ($\alpha_{gap} = 1,0$)					
HDA-P	$V_{Rd,C2}$ [kN]	19,0	27,0	49,3	74,1
HDA-PR		17,4	27,1	54,7	-

Design resistance in case of seismic performance category C1: Tension

Anchor size		M10	M12	M16	M20
Effective anchorage depth	h_{ef} [mm]	100	125	190	250
Cracked concrete					
HDA-P, HDA-T	$N_{Rd,C1}$ [kN]	26,5	37,1	69,5	104,9
HDA-PR, HDA-TR		26,5	37,1	69,5	-

Design resistance in case of seismic performance category C1: Shear

Anchor size		M10				M12				M16				M20			
Effective anchorage depth	h_{ef} [mm]	100				125				190				250			
Without filling set ($\alpha_{gap} = 0,5$)																	
HDA-T	$t_{fix,min}$ [mm]	10	15	10	15	20	15	25	30	35	20	25	40	55			
	$t_{fix,max}$ [mm]	<15	20	<15	<20	50	<25	<30	<35	60	<25	<40	<55	100			
	$V_{Rd,C1}$ [kN]	20,3	23,4	25,9	26,7	33,4	47,1	51,7	56,7	63,4	61,0	68,4	78,4	83,4			
HDA-TR	$t_{fix,min}$ [mm]	10		10		30		15				-					
	$t_{fix,max}$ [mm]	20		<30		50		60				-					
	$V_{Rd,C1}$ [kN]	29,1		36,6		41,0		64,3				-					
With filling set ($\alpha_{gap} = 1,0$)																	
HDA-T	$t_{fix,min}$ [mm]	10	15	10	15	20	15	25	30	35	20	25	40	55			
	$t_{fix,max}$ [mm]	<15	20	<15	<20	50	<25	<30	<35	60	<25	<40	<55	100			
	$V_{Rd,C1}$ [kN]	40,5	46,7	51,7	53,3	66,7	94,1	103,3	113,3	126,7	121,8	136,7	156,7	166,7			
HDA-TR	$t_{fix,min}$ [mm]	10		10		30		15				-					
	$t_{fix,max}$ [mm]	20		<30		50		60				-					
	$V_{Rd,C1}$ [kN]	58,1		73,2		82,0		128,6				-					
Without filling set ($\alpha_{gap} = 0,5$)																	
HDA-P	$V_{Rd,C1}$ [kN]	10,6				15,1				27,1				41,6			
HDA-PR		9,5				14,3				28,6				-			
With filling set ($\alpha_{gap} = 1,0$)																	
HDA-P	$V_{Rd,C1}$ [kN]	23,4				33,8				57,4				88,8			
HDA-PR		22,6				34,0				63,8				-			

Fire loading based on ETA-99/0009. Design according to EN 1992-4
All data in this section applies to:

- Correct setting (see Instructions for use (IFU))
- For a single anchor
- No edge distance and spacing influence (see setting detail tables with characteristic distances)
- Minimum base material thickness (See setting details table)
- Embedment depth, as specified in the table of this section
- Anchor material, as specified in the tables of this section
- Concrete C20/25
- Hammer drilled holes
- Partial safety factor for resistance under fire exposure $\gamma_{M,fi} = 1,0$

For specific design cases refer to **[PROFIS Engineering](#)**.

Anchor size HDA-P			M10	M12	M16	M20
Effective anchorage depth	h_{ef}	[mm]	100	125	190	250
Fire Exposure R30						
Tension	$N_{Rd,fi}$	[kN]	0,87	1,69	3,14	4,81
Shear	$V_{Rd,fi}$	[kN]	0,87	1,69	3,14	4,81
Fire Exposure R60						
Tension	$N_{Rd,fi}$	[kN]	0,75	1,26	2,36	3,61
Shear	$V_{Rd,fi}$	[kN]	0,75	1,26	2,36	3,61
Fire Exposure R90						
Tension	$N_{Rd,fi}$	[kN]	0,58	1,10	2,04	3,13
Shear	$V_{Rd,fi}$	[kN]	0,58	1,10	2,04	3,13
Fire Exposure R120						
Tension	$N_{Rd,fi}$	[kN]	0,46	0,84	1,57	2,41
Shear	$V_{Rd,fi}$	[kN]	0,46	0,84	1,57	2,41

Anchor size HDA-PR			M10	M12	M16
Effective anchorage depth	h_{ef}	[mm]	100	125	190
Fire Exposure R30					
Tension	$N_{Rd,fi}$	[kN]	1,45	2,53	4,71
Shear	$V_{Rd,fi}$	[kN]	1,45	2,53	4,71
Fire Exposure R60					
Tension	$N_{Rd,fi}$	[kN]	1,16	2,11	3,93
Shear	$V_{Rd,fi}$	[kN]	1,16	2,11	3,93
Fire Exposure R90					
Tension	$N_{Rd,fi}$	[kN]	0,93	1,69	3,14
Shear	$V_{Rd,fi}$	[kN]	0,93	1,69	3,14
Fire Exposure R120					
Tension	$N_{Rd,fi}$	[kN]	0,81	1,35	2,51
Shear	$V_{Rd,fi}$	[kN]	0,81	1,35	2,51



Anchor size HDA-T			M10	M12	M16	M20
Effective anchorage depth	h_{ef}	[mm]	100	125	190	250
Fire Exposure R30						
Tension	$N_{Rd,fi}$	[kN]	0,87	1,69	3,14	4,81
Shear	$V_{Rd,fi}$	[kN]	3,88	6,23	12,12	17,77
Fire Exposure R60						
Tension	$N_{Rd,fi}$	[kN]	0,75	1,26	2,36	3,61
Shear	$V_{Rd,fi}$	[kN]	3,36	4,67	9,09	13,32
Fire Exposure R90						
Tension	$N_{Rd,fi}$	[kN]	0,58	1,10	2,04	3,13
Shear	$V_{Rd,fi}$	[kN]	2,59	4,05	7,88	11,55
Fire Exposure R120						
Tension	$N_{Rd,fi}$	[kN]	0,46	0,84	1,57	2,41
Shear	$V_{Rd,fi}$	[kN]	2,07	3,12	6,06	8,88

Anchor size HDA-TR			M10	M12	M16
Effective anchorage depth	h_{ef}	[mm]	100	125	190
Fire Exposure R30					
Tension	$N_{Rd,fi}$	[kN]	1,45	2,53	4,71
Shear	$V_{Rd,fi}$	[kN]	6,47	9,35	18,18
Fire Exposure R60					
Tension	$N_{Rd,fi}$	[kN]	1,16	2,11	3,93
Shear	$V_{Rd,fi}$	[kN]	5,18	7,79	15,15
Fire Exposure R90					
Tension	$N_{Rd,fi}$	[kN]	0,93	1,69	3,14
Shear	$V_{Rd,fi}$	[kN]	4,14	6,23	12,12
Fire Exposure R120					
Tension	$N_{Rd,fi}$	[kN]	0,81	1,35	2,51
Shear	$V_{Rd,fi}$	[kN]	3,62	4,98	9,69

Fatigue loading based on ETA-18/0974. Design according to EN 1992-4

All data in this section applies to:

- Correct setting using Hilti seismic filling set (See setting details)
- For a single anchor
- No edge distance and spacing influence (see table with characteristic distances).
- Characteristic spacing and edge distance for splitting failure apply only for uncracked concrete.
For cracked concrete only the characteristic spacing and edge distance for concrete cone failure are decisive
- Minimum base material thickness (See setting details)
- Embedment depth, as specified in the table of this section
- Anchor material, as specified in the tables of this section
- Concrete C 20/25
- Hammer drilled holes

For specific design cases refer to **PROFIS Engineering.**

Design resistance

Anchor size			M10	M12	M16	M20
Effective anchorage depth	h_{ef}	[mm]	100	125	190	250
Uncracked concrete						
Tension	HDA-P	$\Delta N_{Rd,0,\infty}$ [kN]	6,8	12,1	16,8	19,8
	HDA-T		6,8	12,1	16,8	19,8
Shear	HDA-P	$\Delta V_{Rd,0,\infty}$ [kN]	1,9	4,4	6,7	13,0
	HDA-T		6,3	11,1	17,0	13,0
Cracked concrete						
Tension	HDA-P	$\Delta N_{Rd,0,\infty}$ [kN]	6,8	12,1	16,8	19,8
	HDA-T		6,8	12,1	16,8	19,8
Shear	HDA-P	$\Delta V_{Rd,0,\infty}$ [kN]	1,9	4,4	6,7	13,0
	HDA-T		6,3	11,1	17,0	13,0

Setting information

Setting details

Anchor size		HDA-P / HDA-PR / HDA-PF							
		M10		M12		M16		M20	
		x100/20	x125/30	x125/50	x190/40	x190/60	x250/50	x250/100	
Length code letter		I	L	N	R	S	V	X	
Nominal diameter of drill bit	d_0 [mm]	20	22		30		37		
Depth of drill hole	h_1 [mm]	107	133		203		266		
Effective anchorage depth	h_{ef} [mm]	100	125		190		250		
Sleeve recess ¹⁾	$h_{s,min}$ [mm]	2	2		2		2		
	$h_{s,max}$ [mm]	6	7		8		8		
Torque moment	T_{inst} [Nm]	50	80		120		300		
Max. diameter of clearance hole in the fixture	d_f [mm]	12	14		18		22		
Minimum base material thickness	h_{min} [mm]	180	200		270 ²⁾		350		
Minimum spacing	s_{min} [mm]	80	90		120		150		
Minimum edge distance	c_{min} [mm]	80	90		120		150		
Fixture thicknesses (Minimum fixture thickness is 10 mm under cyclic loads according to ETA-18/0974)									
Minimum fixture thickness	$t_{fix,min}$ [mm]	0	0		0		0		
Thickness of Hilti filling set	h_{fs} [mm]	9	10		11		13		
Effective fixture thickness with Hilti filling set	$t_{fix,ef}$ [mm]	$t_{fix} - h_{fs}$							
Characteristic distances									
Spacing for splitting failure	$s_{cr,sp}$ [mm]	300	375		570		750		
Edge distance for splitting failure	$c_{cr,sp}$ [mm]	150	190		285		375		
Spacing for concrete cone failure	$s_{cr,N}$ [mm]	300	375		570		750		
Edge distance for concrete cone failure	$c_{cr,N}$ [mm]	150	190		285		375		

¹⁾ Please see IFU for more information

²⁾ With TE 70-(04) Rotary Hammers: $h_{min} \geq 300$ mm, please see the IFU section for more details.

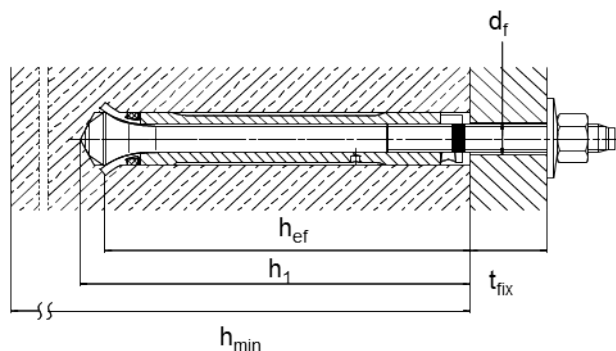

HDA-P / HDA-PR



Filling set

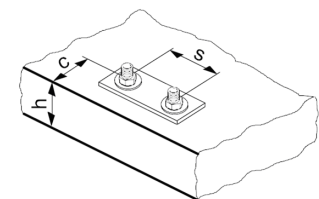

Setting details

Anchor size		HDA-T / HDA-TR / HDA-TF						
		M10	M12		M16		M20	
		x100/20	x125/30	x125/50	x190/40	x190/60	x250/50	x250/100
Length code letter		I	L	N	R	S	V	X
Nominal diameter of drill bit diameter	d_0 [mm]	20	22		30		37	
Depth of drill hole	$h_{1,min}$ [mm]	107	133		203		266	
Effective anchorage depth	h_{ef} [mm]	100	125		190		250	
Sleeve recess ¹⁾	$h_{s,min}$ [mm]	2	2		2		2	
	$h_{s,max}$ [mm]	6	7		8		8	
Torque moment	T_{inst} [Nm]	50	80		120		300	
Max. diameter of clearance hole in the fixture	d_f [mm]	21	23		32		40	
Minimum base material thickness	h_{min} [mm]	200- t_{fix}	230- t_{fix}	250- t_{fix}	310- t_{fix}	330- t_{fix}	400- t_{fix}	450- t_{fix}
Minimum spacing	s_{min} [mm]	80	90		120		150	
Minimum edge distance	c_{min} [mm]	80	90		120		150	
Fixture thicknesses (Minimum fixture thickness is 10 mm under cyclic loads according to ETA-18/0974)								
Minimum fixture thickness	$t_{fix,min}$ [mm]	10	10		15		20	
Max. fixture thickness	$t_{fix,max}$ [mm]	20	30	50	40	60	50	100
Thickness of Hilti filling set	h_{fs} [mm]	9	10		11		13	
Effective fixture thickness with Hilti filling set	$t_{fix,ef}$ [mm]	$t_{fix} - h_{fs}$						
Characteristic distances								
Spacing for splitting failure	$s_{cr,sp}$ [mm]	300	375		570		750	
Edge distance for splitting failure	$c_{cr,sp}$ [mm]	150	190		285		375	
Spacing for concrete cone failure	$s_{cr,N}$ [mm]	300	375		570		750	
Edge distance for concrete cone failure	$c_{cr,N}$ [mm]	150	190		285		375	

¹⁾ Please see IFU for more information

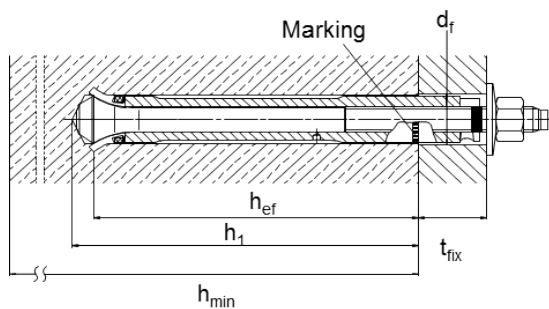

HDA-T / HDA-TR





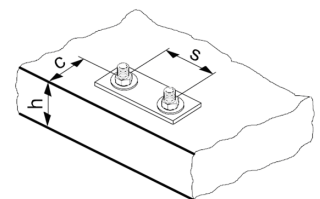



Filling set





Drilling and Installation equipment

For detailed setting information on installation see instructions (IFU) for use given with the product.

Rotary Hammers (Corded and Cordless)		TE 30 - TE 70
		Torque Tool
		Stop drill bit TE-C-HDA-B / TE-Y-HDA-B
		Setting Tool TE-C-HDA-ST / TE-Y-HDA-ST
		Blow out pump
		Anchor removal tool TE-C-HDA-RT
		Grinding tool TE-C-HDA-GT